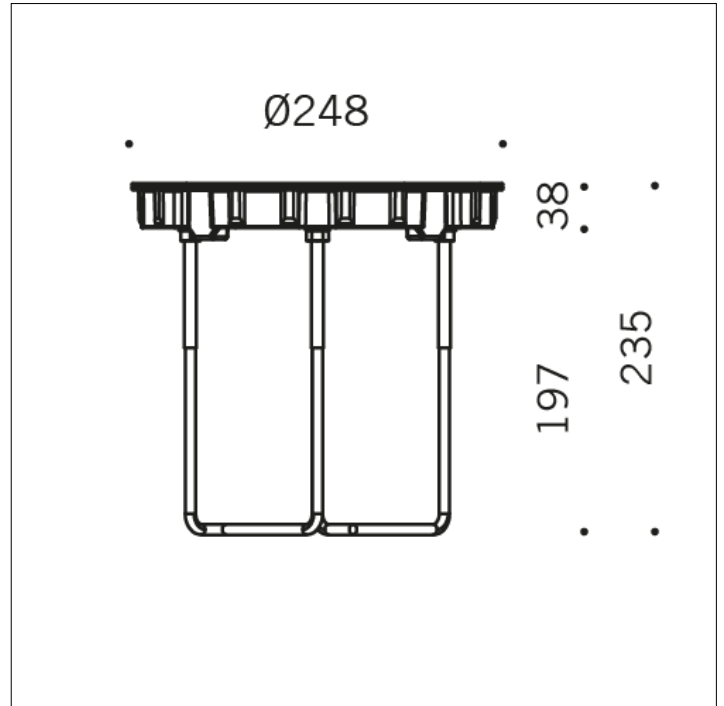

ACCESSORY

**S.2119
FLANGE**

Flange $\text{Ø} 248\text{mm}$ h 235mm to be fixed in concrete with steel screws treated with an advanced anticorrosive coating for fixing in the ground. Footstall dimension can be calculated according to your country norms and ground properties.